

## 2-WAY COMPONENTS

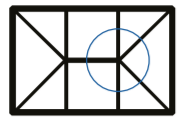

**XLANRE2-TC**  
Ridge End Fixed 20°  
2-Way Top Cap

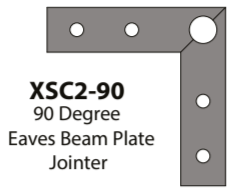

**XSC2-90**  
90 Degree  
Eaves Beam Plate  
Joinder

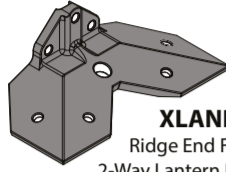

**XLANRE2**  
Ridge End Fixed 20°  
2-Way Lantern Roof Casting



**XLANRE2-BC**  
Ridge End 2-Way  
Internal Cover

## 3-WAY COMPONENTS

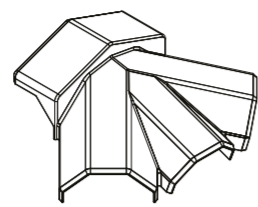
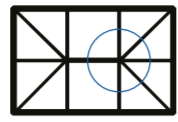

**XLANRE3-TC**  
Ridge End Fixed 20°  
3-Way Top Cap

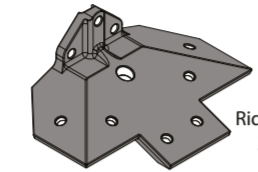

**XLANRE3**  
Ridge End Fixed 20°  
3-Way Lantern  
Roof Casting

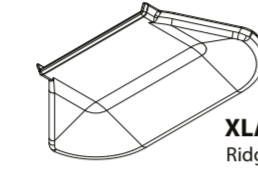

**XLANRE3-BC**  
Ridge End 3-Way  
Internal Cover

## 4-WAY COMPONENTS

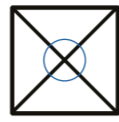

**XLAN-PYR-TC**  
4-way Top Cap



**XLANRE-PYR-BC**  
4-way Radius End  
Bottom Cap

## STRATUS COMPONENTS



**K2-KDC8031**  
Ridge Holding Bolt  
200mm Long  
(M8 Nylon)

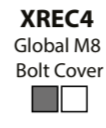

**XREC4**  
Global M8  
Bolt Cover

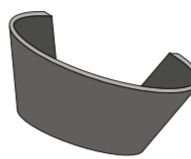

**XLANRE-FB1**  
Radius End  
Foam Infill

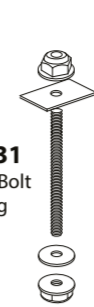

**XLAN-M516**  
M5 x 16mm  
Fixing Bolt

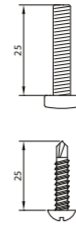

**XM525**  
M5 x 25mm  
Ridge to Radius End  
Machine Screw

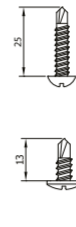

**8PSR42-25BLK**  
4.2 x 25mm  
End Cap Screw



**K2-C9545**  
4.2 x 13mm  
Eaves Beam Plate  
Joinder Screw



**XLAN-M520**  
M5 x 20mm  
Pozzi Panhead  
Machine Screws  
& 2x M5 Nyloc Nuts

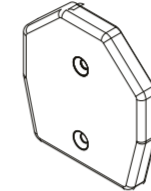

**XLANT1-EC**  
Rafter & Georgian  
Hip End Cap

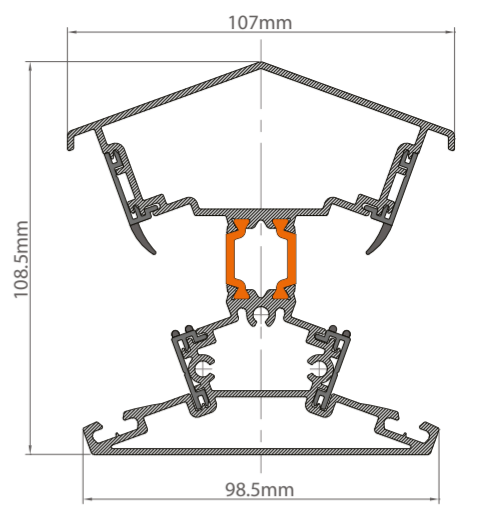

**RIDGE ASSEMBLY**

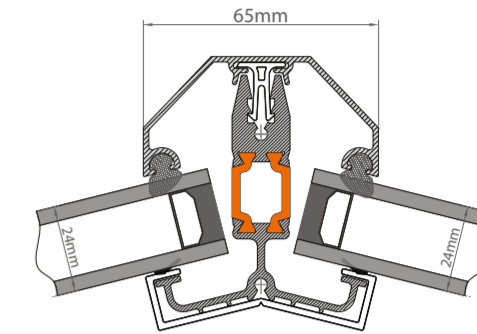

**GEORGIAN HIP RAFTER ASSEMBLY**

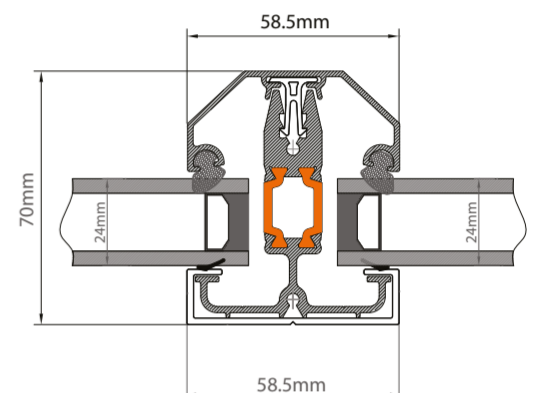

**RAFTER ASSEMBLY**

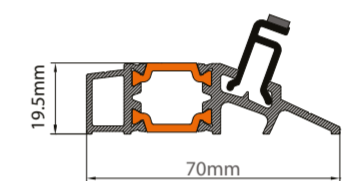

**EAVES BEAM ASSEMBLY**

## STRATUS EXTRUSIONS

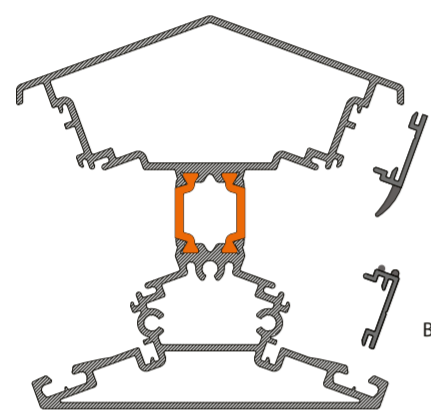

**XLANR20**  
Ridge

**XLAN-P6030**  
Top Cloaking Trim

**K2-KDP6028**  
Bottom Cloaking Trim

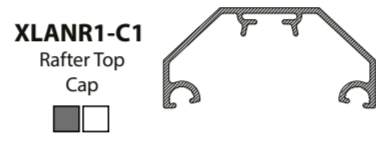
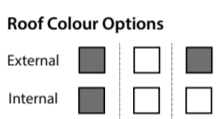

**XLANR1-C1**  
Rafter Top  
Cap

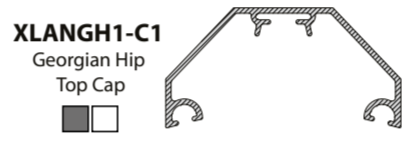

**XLANGH1-C1**  
Georgian Hip  
Top Cap



**K2-KDA5161**  
Aluminium  
End Closer



**XLANEB2**  
Eaves Beam Plate

**XLAN-P6074**  
Top Cap Clip

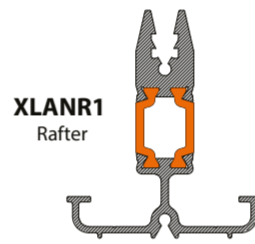

**XLANR1**  
Rafter



**XLANGH1**  
Georgian Hip

**K2-C9060**  
Q-Lon Weather Seal

**XPS1**  
PVC-U Support  
Infill

**XBC2**  
Rafter Bottom Cap

**COLOUR GUIDE**  
Grey RAL 7016  
White RAL 9016  
Black RAL 9005

## Lantern cross section

Use these guides to aid setting out your Stratus Thermal Lantern Roof correctly

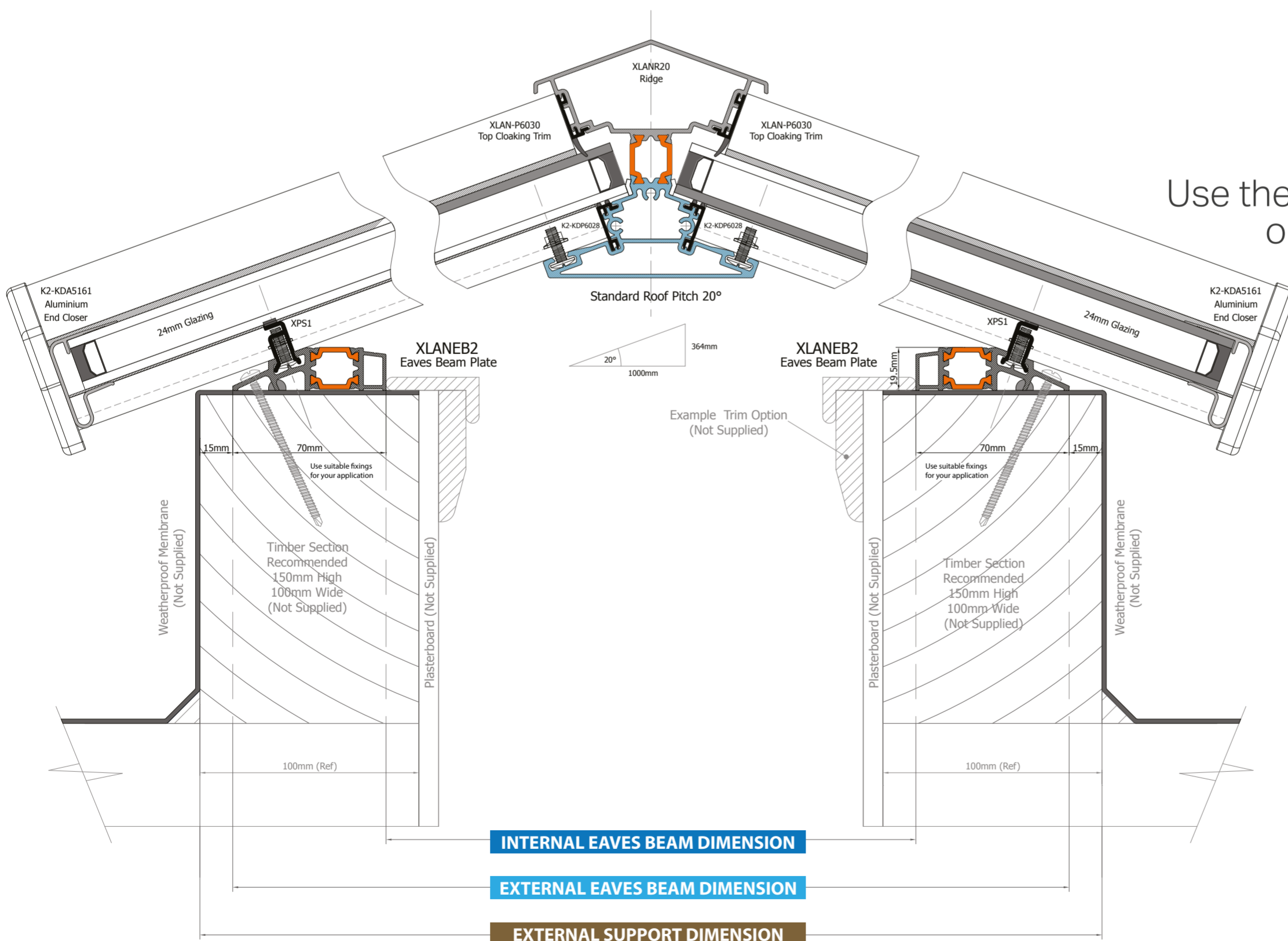

**INTERNAL EAVES BEAM DIMENSION**

▼ +140mm ( 70mm + 70mm ) ▼

**EXTERNAL EAVES BEAM DIMENSION**

**EXTERNAL EAVES BEAM DIMENSION**

▼ +30mm ( 15mm + 15mm ) ▼

**EXTERNAL SUPPORT DIMENSION**

**INTERNAL EAVES BEAM DIMENSION**

▼ +170mm ( 85mm + 85mm ) ▼

**EXTERNAL SUPPORT DIMENSION**

**FOR OPTIMUM LOOKS**  
Width x 1.5 / 2 / 2.5 Length etc.  
example 1400 (W) x 2100mm (L)